

## **BTRP230V(50) THERMOSTAT - FULL USER MANUAL**





# TABLE OF CONTENTS

<b>1. Introduction</b> .....	<b>4</b>
1.1 Product Compliance .....	4
1.2 Safety Informations.....	4
1.3 Product Overview .....	5
<b>2. Montage</b> .....	<b>6</b>
2.1 Package content .....	6
2.2 Proper thermostat location .....	6
2.3 Connection description.....	7
<b>I A</b> - 4 wire installation with KL08NSB wiring centre.....	8
<b>I B</b> - 4 wire installation with KL06 wiring centre .....	10
<b>II</b> - 3 wire installation with KL08NSB wiring centre .....	12
<b>III A</b> - work with RM-16A relay module - volt-free heating source control.....	14
<b>III B</b> - work with RM-16A relay module - connection to a solid fuel boiler controller.....	14
<b>III C</b> - work with RM-16A relay module - connecting an electrical device with a higher power .....	15
<b>3. Before you start (first power up)</b> .....	<b>16</b>
3.1 LCD icon description .....	16
3.2 Button description.....	16
3.3 First power up sequence.....	17
<b>4. Work modes</b> .....	<b>18</b>
<b>5. User settings (basic settings)</b> .....	<b>19</b>
5.1 Schedule mode - programming schedule.....	19
5.2 Time/Date .....	22
5.3 Thermostat calibration .....	23
5.4 Heat/cool mode change .....	24
<b>6. Installer parameters</b> .....	<b>25</b>
<b>7. Factory Reset</b> .....	<b>27</b>
<b>8. Error codes</b> .....	<b>28</b>
<b>9. Cleaning and Maintenance</b> .....	<b>29</b>
<b>10. Technical Informations</b> .....	<b>29</b>
<b>11. Warranty</b> .....	<b>30</b>

# 1. Introduction

## 1.1 Product Compliance

This product complies with the essential requirements and other relevant provisions of Directives 2014/53/EU and 2011/65/EU. The full text of the EU Declaration of Conformity is available at the following internet address: [www.saluslegal.com](http://www.saluslegal.com).

## 1.2 Safety Informations

- Before starting installation work and before using the product, read the entire manual.
- The information contained in the instructions is essential for proper functioning.
- To avoid accidents resulting in personal injury and material damage, please follow all safety precautions, specified in this manual.
- The device should not be used by people with limited mental, sensory or mental abilities, without experience, of insufficient knowledge as well as children.
- Do not use an unassembled device (eg without a cover).
- The device may only be opened by a qualified person.
- Keep electrical devices out of the reach of children and ensure that they do not play with it. Children should not be left unattended. If necessary, disconnect the control system for the entire room.
- Do not leave the packaging, cabinet, or any loose parts of the device unattended, as they pose a risk to children.

### **WARNING!**

- Installation must be carried out by a qualified person with appropriate electrical qualifications in accordance with standards and regulations in force in the given country and in the EU.
- Never try to connect the device other than as described in the manual.
- Before assembly, repair or maintenance as well as during any connection works it is absolutely necessary disconnect the mains supply and make sure that the terminals and electric wires are not live.
- The device may not be exposed to extreme temperatures, strong vibrations or subjected to mechanical shock.
- The device should not be used in unfavorable environmental conditions or in rooms where there is a concentration of flammable gases, fumes or dust.

### **WARNING!**

- There may be additional protection requirements for the entire installation that the installer is responsible for maintaining.



Care for the natural environment is of paramount importance to us. The awareness that we manufacture electronic devices obliges us to dispose of used electronic components and devices safely. Therefore the company has received a registration number issued by the Chief Inspector for Environmental Protection. The crossed out symbol the trash can on the product means that the product must not be disposed of with ordinary waste containers. Sorting waste for recycling helps to protect the environment. It is the user's responsibility to surrender used equipment to a designated collection point for recycling waste from electrical and electronic equipment.

### 1.3 Product Overview

The BTRP230V(50) from SALUS Controls is a stylish and accurate 5/2 or 24h programmable electronic thermostat with a large, easy to read Liquid Crystal Display (LCD). It is flush-mounted (in a 55 mm frame) temperature controller dedicated for surface heating / cooling, characterized by high thermal inertia. It is connected to the wired wiring centre KL08NSB. Thermostat has the function of creating your own schedules. It can control group (SLAVE) thermostats - via wiring centre it sends them an NSB (nighttime temperature reduction) signal and switches them to economic temperature. The time schedule is common to all thermostats (according to weekly (MASTER) thermostat), but temperatures are set individually on each thermostat.

The programmable room thermostat BTRP230V(50) is both a programmer and a room thermostat. A programmer allows you to set 'ON' and 'OFF' time periods to suit your own lifestyle. A room thermostat works by sensing the air temperature, switching on the heating when the air temperature falls below the thermostat setting and switching it off once this set temperature has been reached.

So, a programmable room thermostat lets you choose what times you want the heating to be on, and what temperature it should reach while it is on. It will allow you to select different temperatures in your home at different times of the day (and days of the week) to meet your particular needs.

Turning a programmable room thermostat to a higher setting will not make the room heat up any faster. How quickly the room heats up depends on the design of the heating system, for example, the size of boiler. Neither does the setting affect how quickly the room cools down. Turning a programmable room thermostat to a lower setting will result in the room being controlled at a lower temperature, and saves energy.

The way to set and use your programmable room thermostat is to find the lowest temperature settings that you are comfortable with at the different times you have chosen, and then leave it alone to do its job. The best way to do this is to set low temperatures first, say 18°C, and then turn them up by one degree each day until you are comfortable with the temperatures. You won't have to adjust the thermostat further. Any adjustments above these settings will waste energy and cost you more money.

#### **PRODUCT ADVANTAGES:**

- absolutely silent operation (TRIAC)
- has a PWM control algorithm
- protection against too high or too low temperature using an additional FS300 floor sensor
- protection of thermostatic valves against stagnation (VP)
- an input for the additional temperature sensor
- has frost protection mode
- mounting in a  $\varnothing$  60 mm wall box

## 2. Montage

### 2.1 Package content

- 1) BTRP230V(50) thermostat
- 2) Short instruction
- 3) Mounting screws



### 2.2 Proper thermostat location

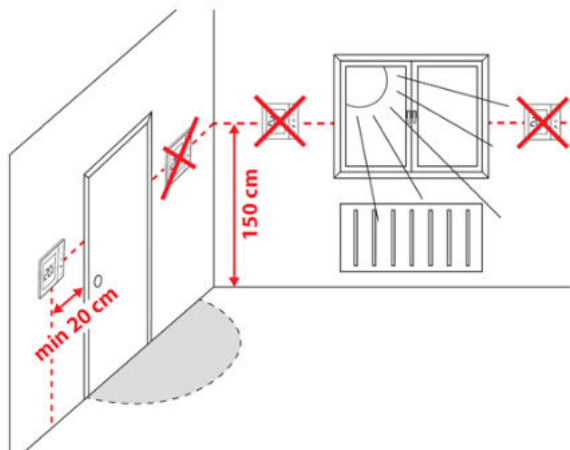

### Please note:

The ideal position to thermostat mounting is about 1,5m under floor level far from heating or cooling sources. Thermostat can't be exposed to sunlight or any extreme conditions like for example draft.

Because of fire and explosion risk there is not allowed to use thermostat in atmosphere of explosive gases and flammable liquids (eg coal dust). In case if any of listed dangers occur you have to use additional protection measures – anti-dust and explosive gases (tight cover) or prevent their formation. Furthermore, thermostat can't be used in condensation of water vapor conditions and be exposed to water action.

### Wall mounting

**Mounting:** to mount thermostat you can use accesories included with the set (mounting screws). Remove back housing to mount it to the wall box. After attachment put together front and back housing.

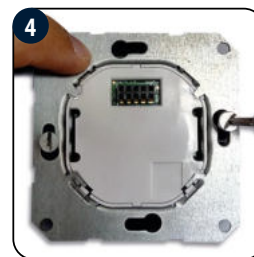

Make sure that wires are not connected to 230V. Then connect the thermostat. Please refer to 2.3 chapter - Connection Description.

Mount the thermostat like in the pictures above (use designed holes for screws).



Install the decorative frame and then slide the front of the thermostat onto its back. The thermostat is ready to work. You can set the desired temperature with the buttons.

## 2.3 Connection description

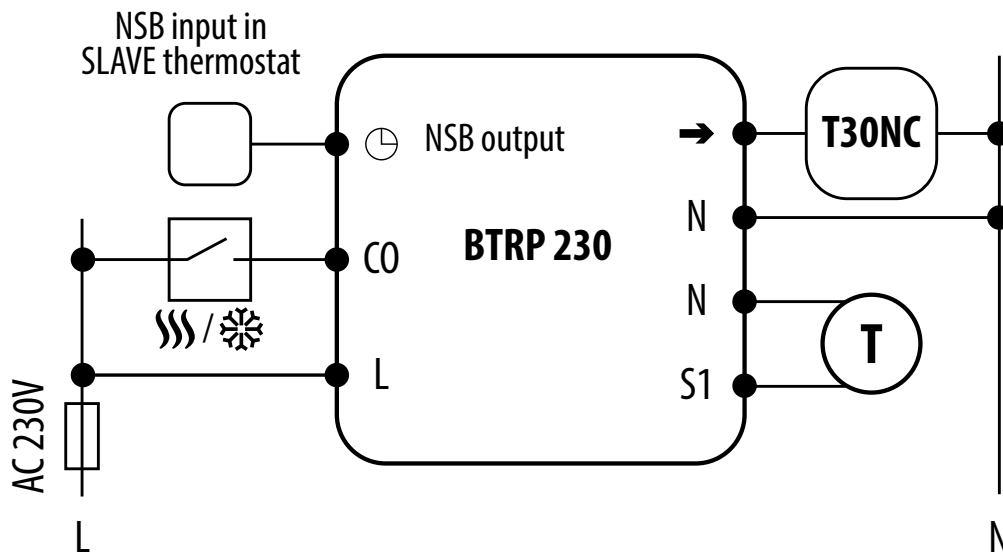

### Legend:



Thermal actuator



Temperature sensor

### Symbols explanation:

**L, N** - power supply 230V

 - **NSB** - Night temperature reduction (230V output)

 - **SL** - 230 V AC output signal

**CO** - Switching jumper between heating and cooling (input 230V AC)

**S1, N** - additional temperature sensor eg. FS300

## IA - 4 wire installation with KL08NSB wiring centre

When BTRP230V(50) thermostat works as a MASTER (group controller) it means it takes control of SLAVE thermostats e.g. BTR230V(20). MASTER thermostat controls SLAVE thermostat only when SLAVE thermostat is in AUTO mode. Comfort (SUN) and economy (MOON) setpoint temperatures are set individually on each thermostat but switching between those temperature is based on time schedule taken from BTRP230(50) thermostat which works like a group controller. Functions such as: setpoint temperature change, holiday mode, party mode or frost protection mode are not managed by MASTER thermostat.

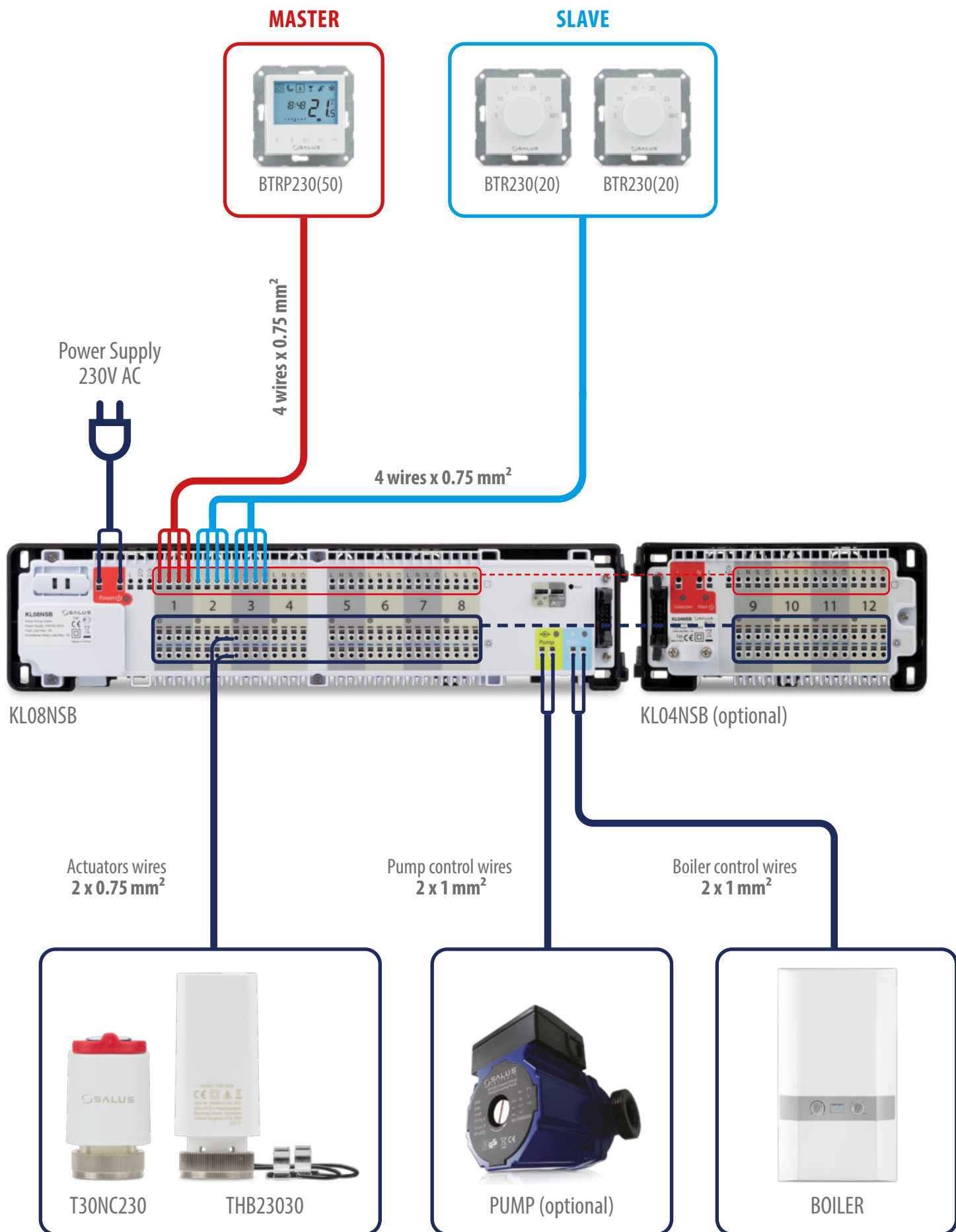



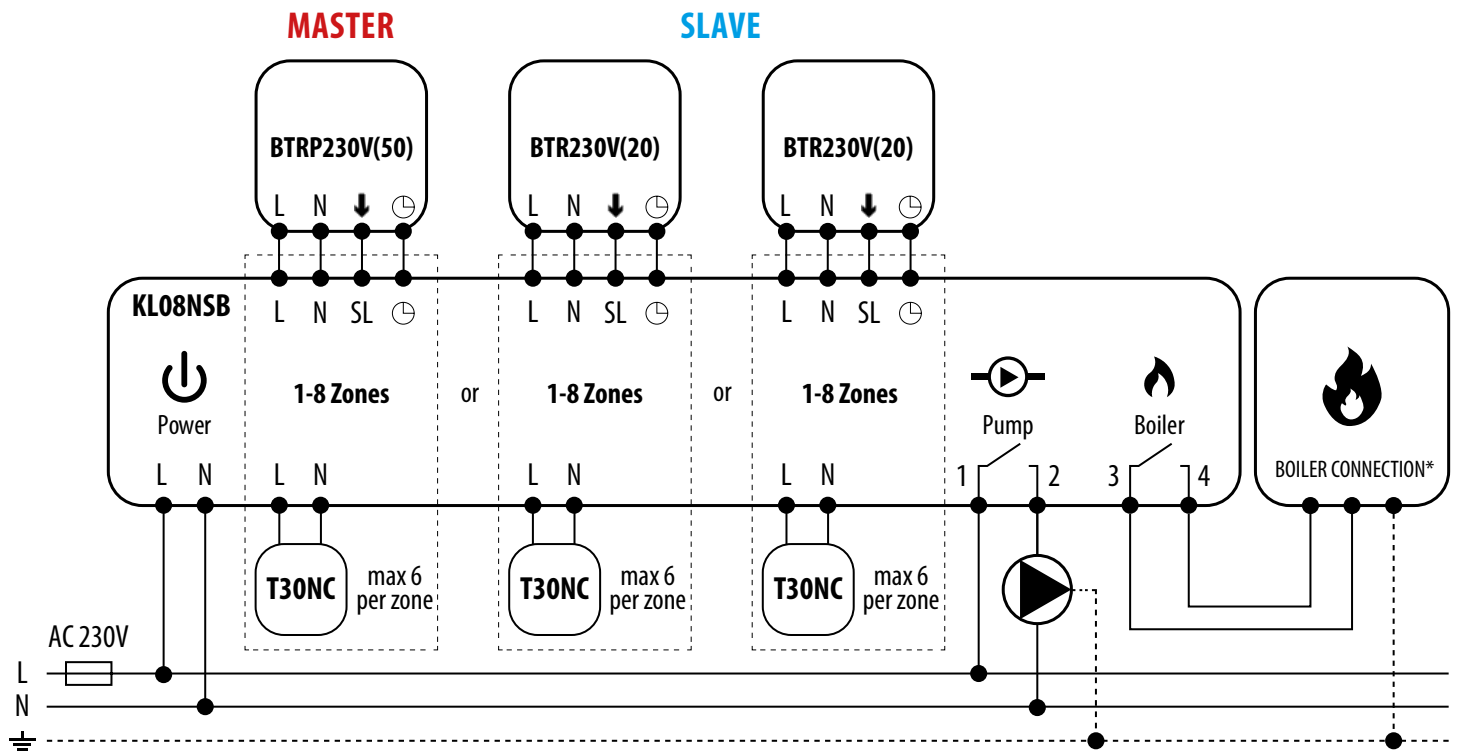

### Legend:



**Boiler - Boiler connection\*** - Boiler's contacts for ON/OFF thermostat (according to the boiler's instructions)



Pump



T30NC Thermal actuator

### Symbols explanation:

L, N - power supply 230V



- NSB - Night temperature reduction (230V output - in MASTER thermostat) (230V input - in SLAVE thermostat)



- SL - 230 V AC actuator control signal



- fuse

# I B - 4 wire installation with KL06 wiring centre

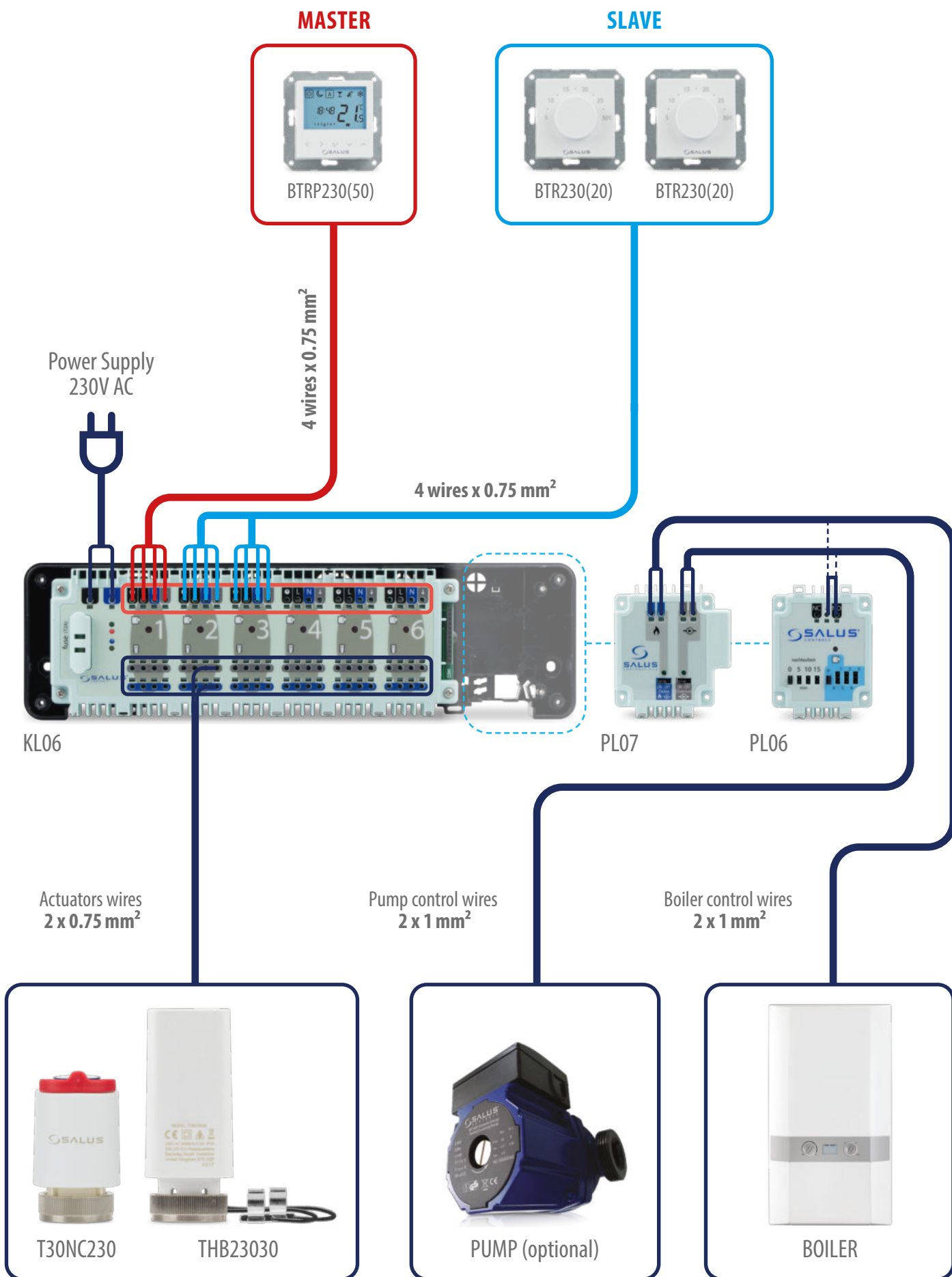

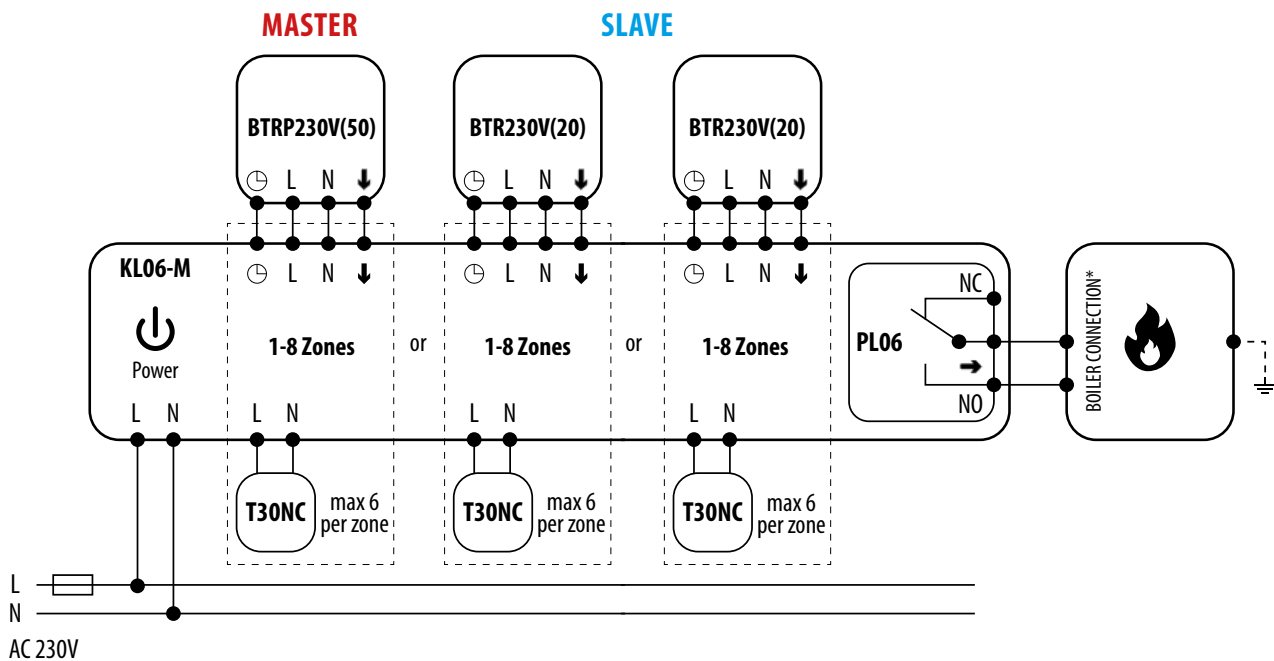

**Legend:**

**Boiler - Boiler connection\*** - Boiler's contacts for ON/OFF thermostat (according to the boiler's instructions)

Pump

Thermal actuator

**Symbols explanation:**

**L, N** - power supply 230V

- **NSB** - Night temperature reduction (230V output - in MASTER thermostat) (230V input - in SLAVE thermostat)

- **SL** - 230 V AC actuator control signal

**NC, NO** - voltage-free output

- fuse

Pump logic module (for KL06) connection diagram

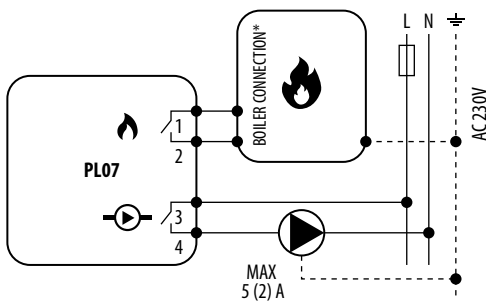

Pump and boiler logic module (for KL06) connection diagram

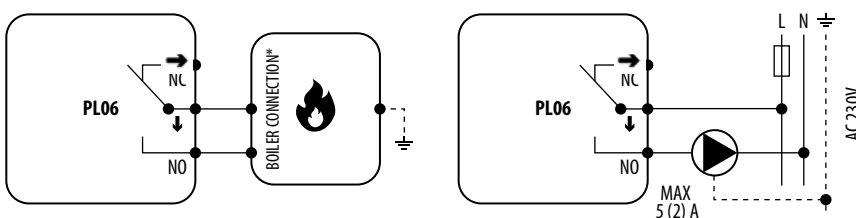

## II - 3 wire installation with KL08NSB wiring centre

3 wire installation with KL08NSB wiring center. Description of the operation rules:

- BTRP230V(50) thermostat's functionality is limited because of 3 wire installation. NSB function is disabled and BTRP230V(50) thermostat doesn't work as a MASTER thermostat - no effect on other thermostats like BTR230V(20)
- schedules can be set individually on each BTRP230V(50) thermostats if system is equipped with more than one BTRP230V(50) thermostat



### PLEASE NOTE!

The same operating rules apply to wiring center KL06.

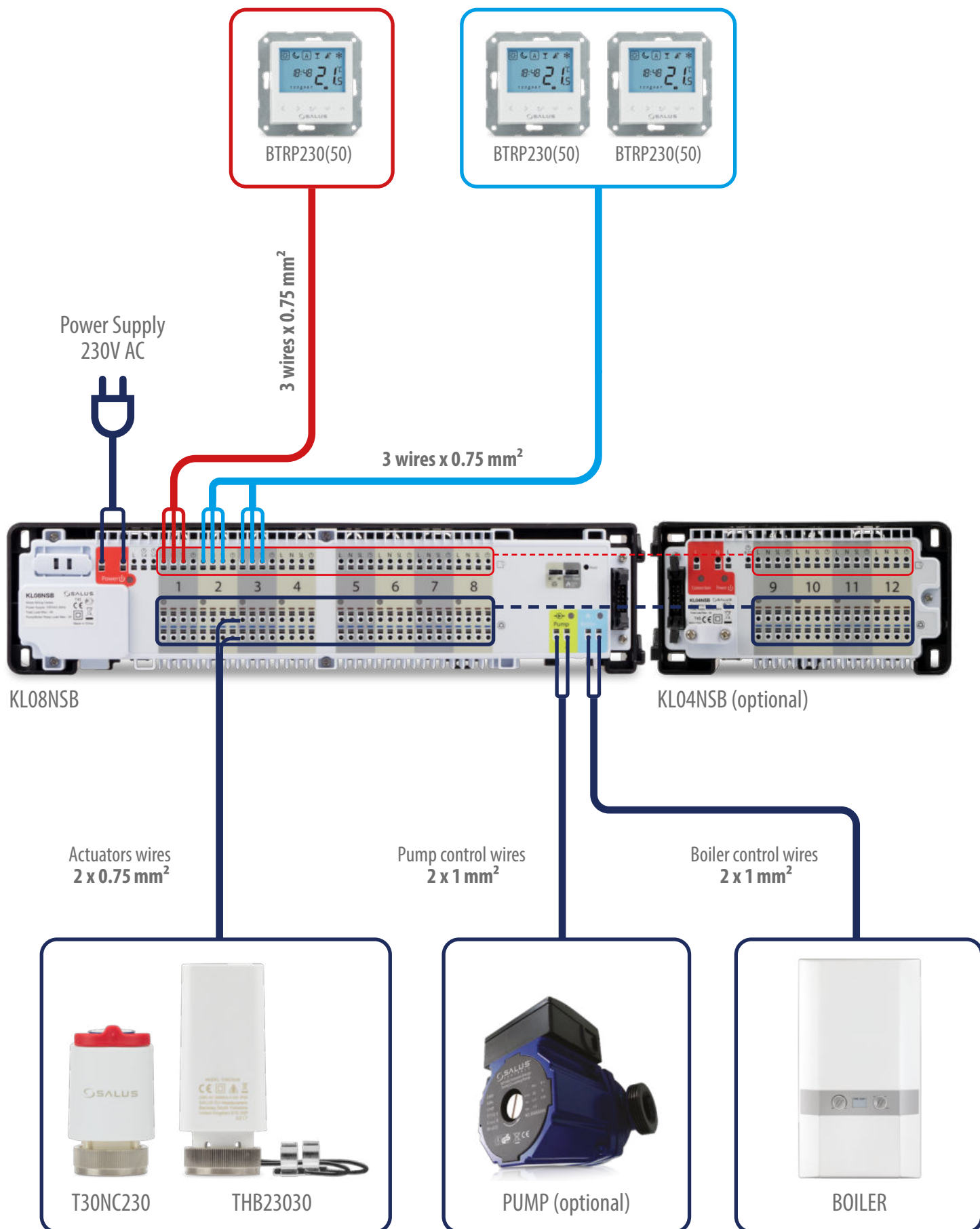

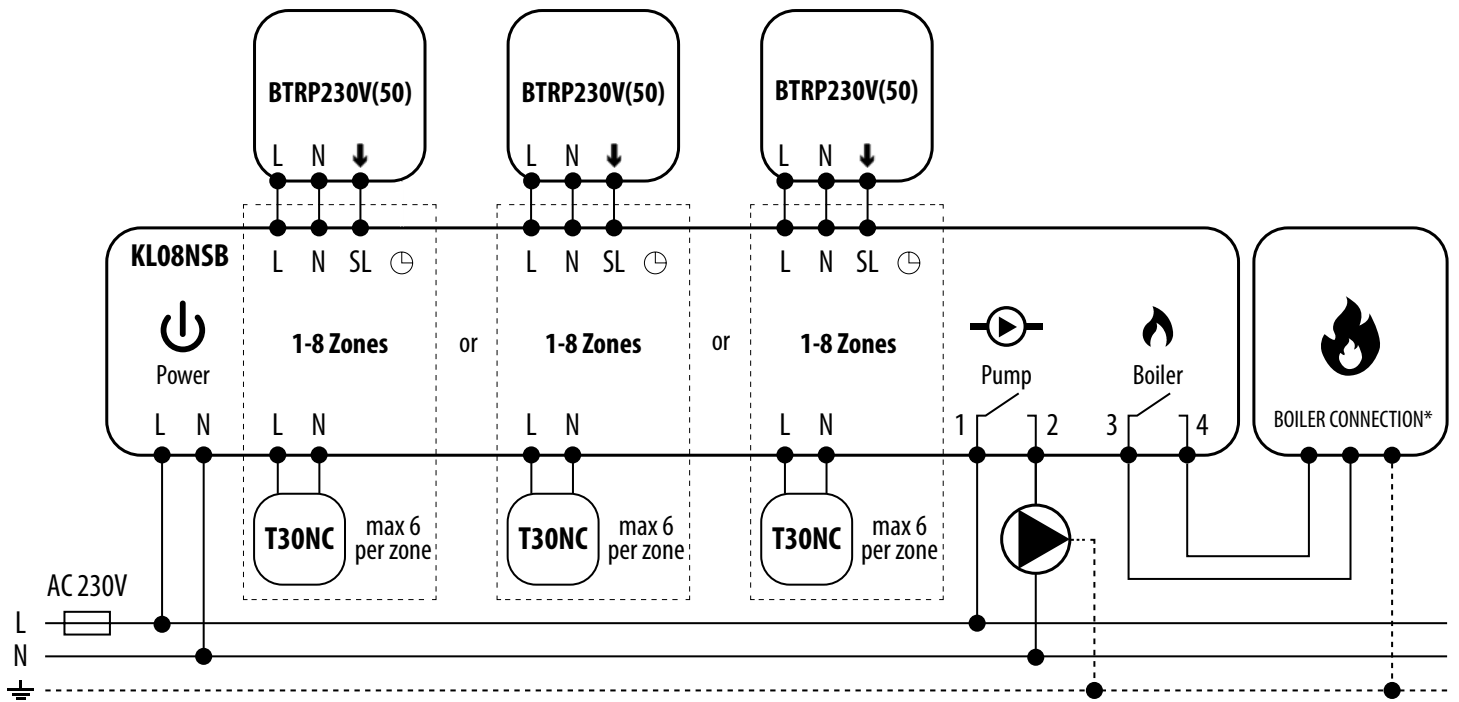

### Legend:



**Boiler - Boiler connection\*** - Boiler's contacts for ON/OFF thermostat (according to the boiler's instructions)



Pump



Thermal actuator

### Symbols explanation:

**L, N** - power supply 230V



**NSB** - Night temperature reduction (230V output)\*\*



**SL** - 230 V AC actuator control signal



- fuse

**\*\* - not used in 3 wire installation**

### III A - work with RM-16A relay module - volt-free heating source control

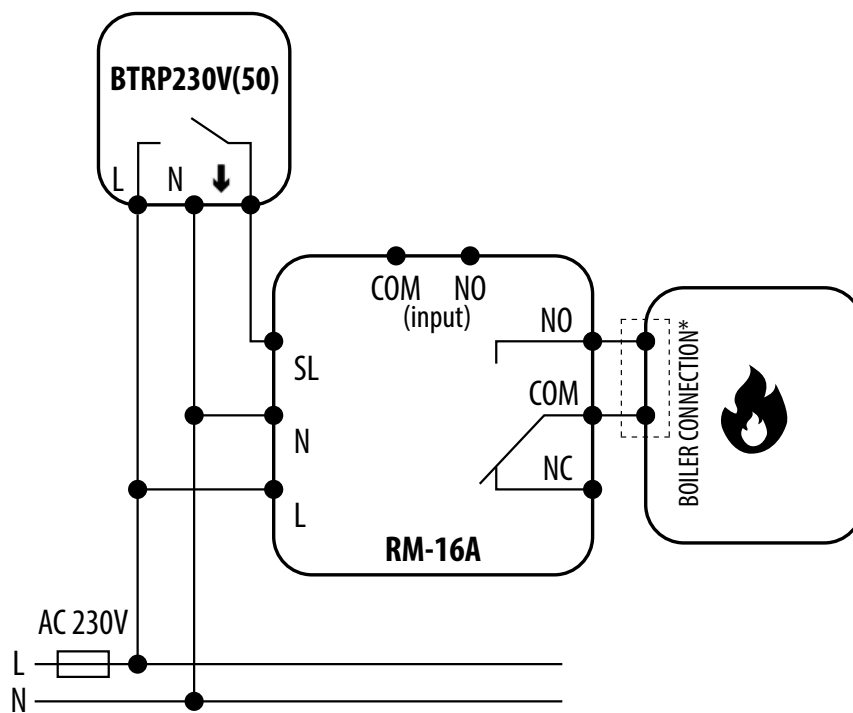

Connection of a 230 V AC voltage thermostat to a boiler (or other device) with an ON - OFF contact.

### III B - work with RM-16A relay module - connection to a solid fuel boiler controller

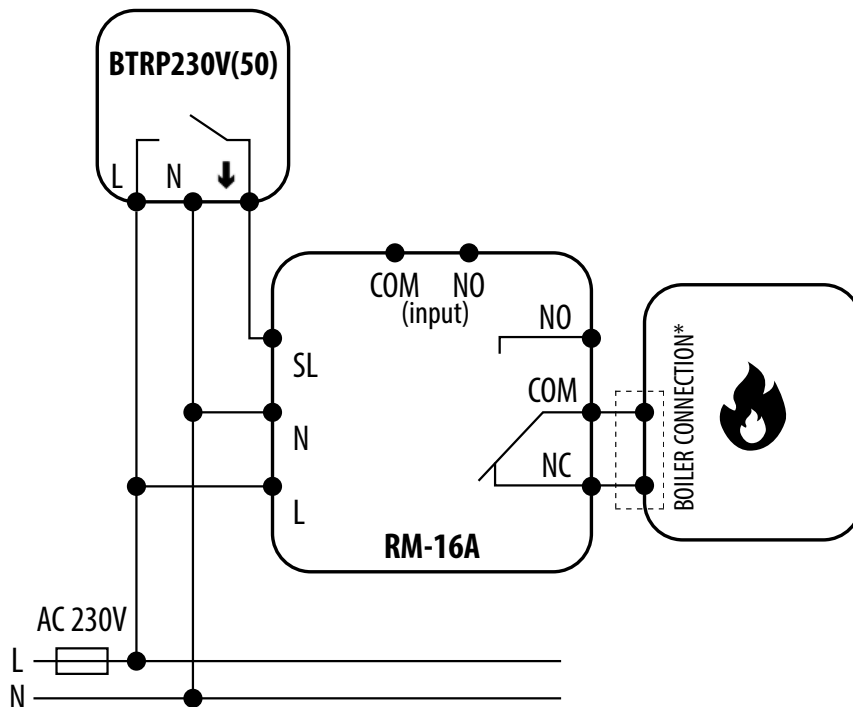

Connection of a 230 V AC voltage thermostat to a solid fuel boiler controller with an ON - OFF contact.



**PLEASE NOTE!** Activate the thermostat in the solid fuel boiler controller.

### III C - work with RM-16A relay module - connecting an electrical device with a higher power than the thermostat relay allows



**PLEASE NOTE!** The maximum current consumption of an electrical device should not exceed 16A.

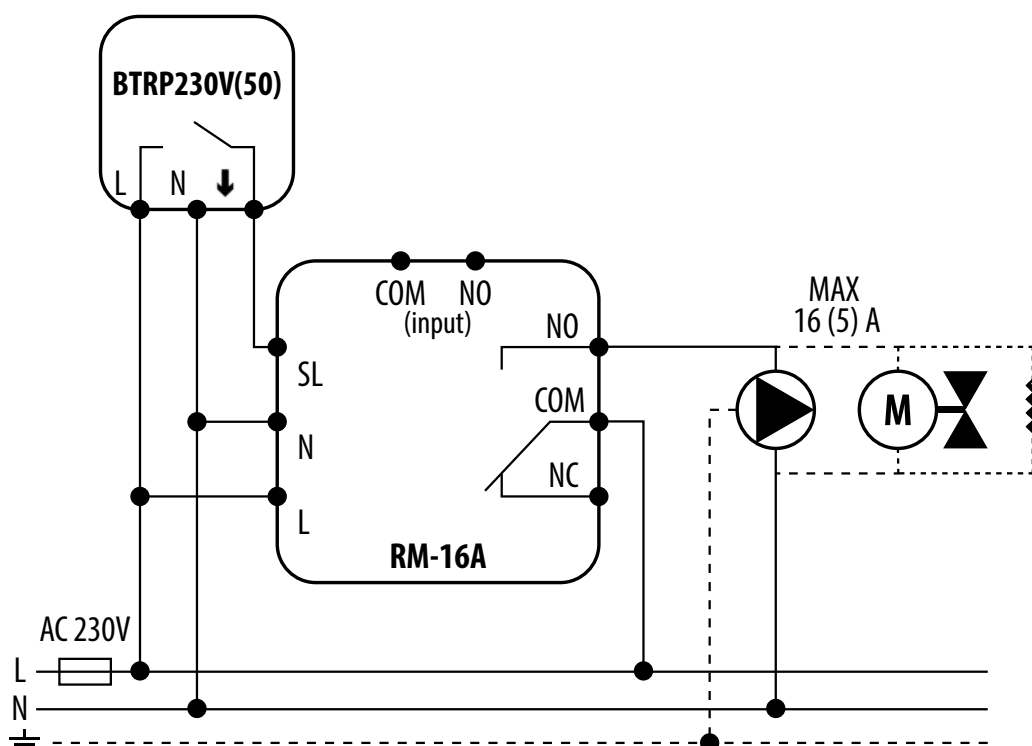

#### Legend:



Pump



Valve actuator



Heating mat

#### Symbols explanation:

L, N - power supply 230V

↓ - SL - 230 V AC control signal

NO, COM, NC - voltage-free output

—|— - fuse

### 3. Before you start (first power up)

#### 3.1 LCD icon description

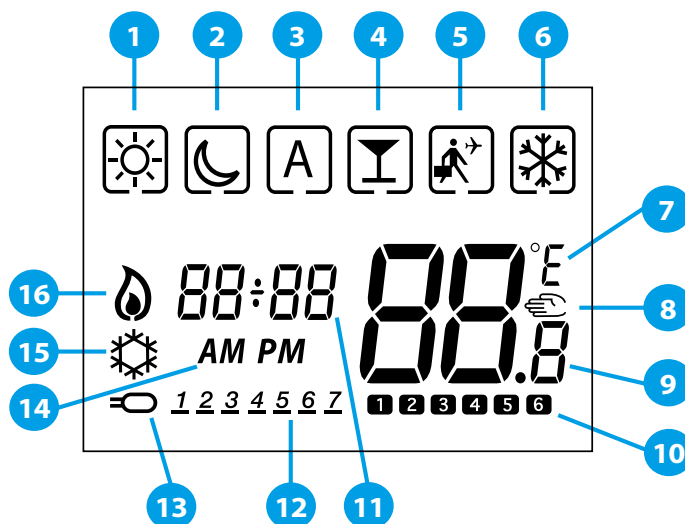

- |                                 |                                 |
|---------------------------------|---------------------------------|
| 1. Comfort temperature          | 9. Current / set temperature    |
| 2. Economic temperature         | 10. Program number              |
| 3. Automatic mode               | 11. Clock                       |
| 4. PARTY mode                   | 12. Day indicator               |
| 5. Holiday mode                 | 13. External temperature sensor |
| 6. Frost protection mode        | 14. AM / PM                     |
| 7. Temperature unit             | 15. Cooling mode ON             |
| 8. Manual mode / override temp. | 16. Heating mode ON             |

#### 3.2 Button description

Button Description	
Button	Function
	1. Increase or decrease setpoint temperature. 2. Increase or decrease Day, Clock, Timer, Party and Holiday. 3. Select installer parameter value.
	1. Mode selection. 2. Moving between parameters.
	1. OK key: Short press to confirm selection. 2. Long press to save and exit. 3. When Main Screen – long press to enter the user settings.
	Hold down these buttons for 3 SECONDS to enter installer parameter settings.

 **PLEASE NOTE!** The LCD screen can be activated by using any button.



### 3.3 First power up sequence

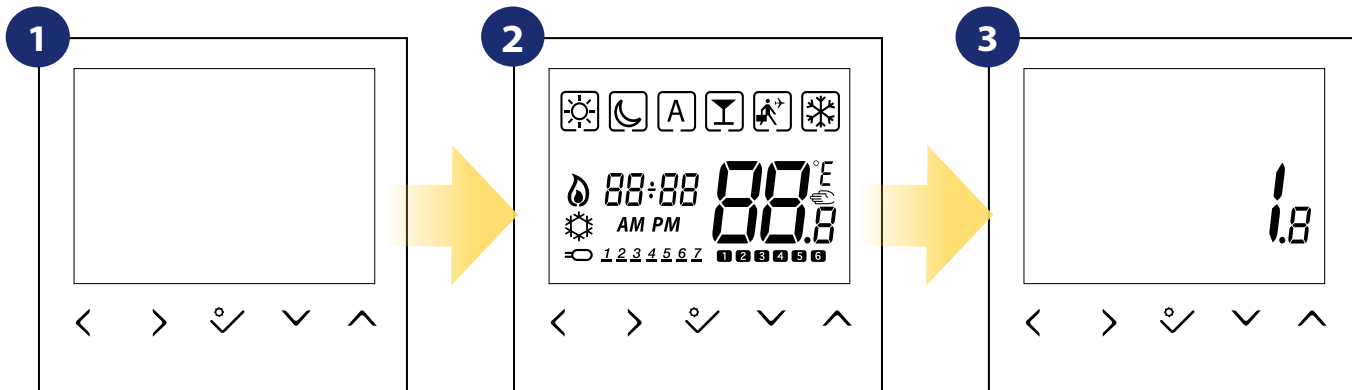

To power on the thermostat you have to connect it to the 230V power supply then...

...display will show all icons...

...then thermostat will display the software version.

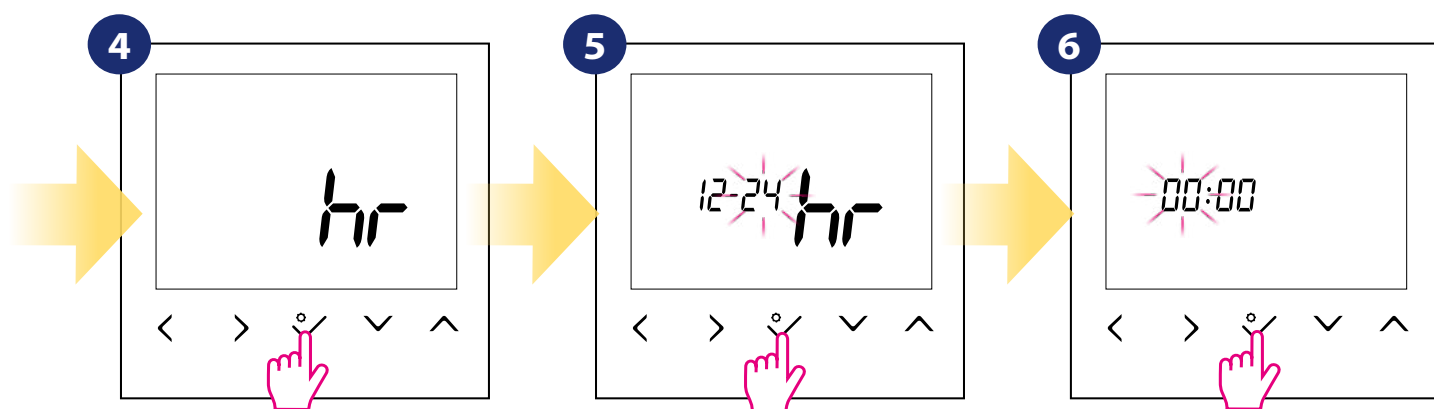

Confirm by ✓ button.

Set time format „<” or „>” buttons.  
Confirm by ✓ button.

Set time (hours and minutes) using  
„v” or „^” buttons.  
Confirm by ✓ button.

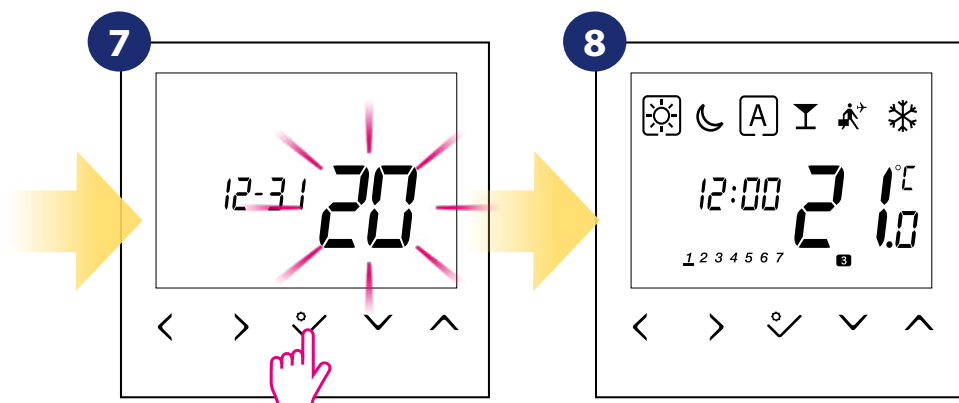

Set date (year, month and day) using  
„v” or „^” buttons.  
Confirm by ✓ button.

After all, the main screen will be displayed.

## 4. Work modes

BTRP230V(50) offers a few work modes. Frame on a given icon indicates which mode is currently active. In manual mode ☀️ or 🌙 only one temperature level is maintained. Thermostat follows programmed schedule when AUTO mode is active („A” icon). Detailed description of work modes is located below:

☐ - **Frame** - means that the work mode is active (the icon of the work mode must be in the center of the frame). For example:

☀️ - means that comfort temperature mode **is active**

☀️ - means that comfort temperature mode **is inactive**

☀️ - **Comfort temperature mode** - pre-defined setpoint temperature. Usually set when we are indoors. The highest maintained temperature in heating mode or the lowest if thermostat works in the cooling system. Acting alone works as a manual mode. Temperature range: from 5°C to 35°C.

🌙 - **Economic temperature mode** - pre-defined setpoint temperature. Usually set at night or when we are out of the house. Acting alone works as a manual mode. Temperature range: from 5°C to 35°C.

A - **Automatic mode temperature (schedule)** - follows programmed schedule. Schedule can be temporarily override with new setpoint temperature (temporary override mode will be active to the next change forced by schedule, ⏸️ hand icon will be displayed).

👤 - **Party mode** - this mode sets the comfort temperature ☀️ for a user-defined time (maximum 9 hours 50 minutes).

🏠 - **Holiday mode** - this mode sets the frost protection mode ❄️ for a user-defined time (maximum 99 days).

❄️ - **Frost protection mode** - usually used during extended periods of absence or during the holidays (only available in heating mode). Temperature range: from 5°C to 17°C.

### Example - comfort temperature mode setpoint editing:

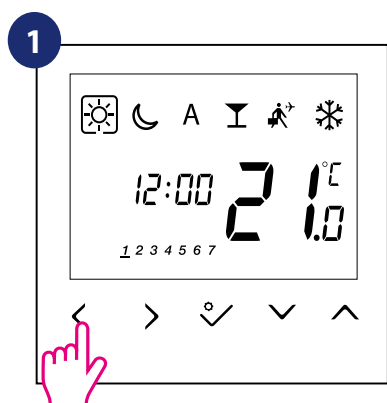

Use < or > buttons to switch between work modes. Choose ☀️ in this case.

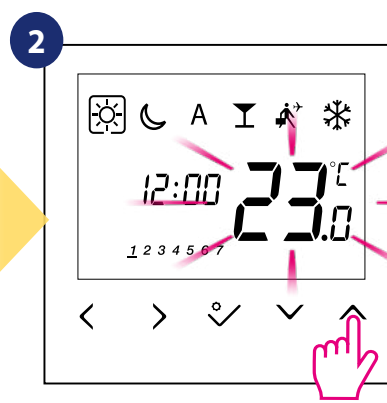

Use ▼ or ▲ buttons set temperature setpoint.

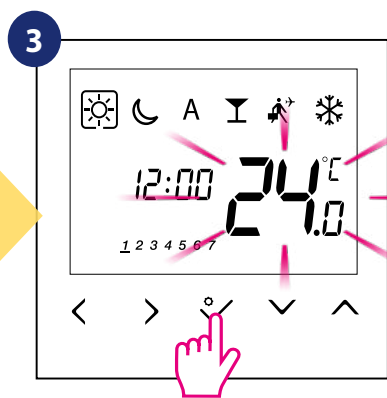

Confirm by ✓ button.

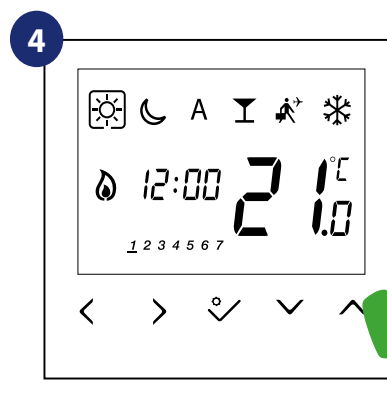



Thermostat will go back to the main screen after saving the settings.

## 5. User settings (basic settings)

### 5.1 Schedule mode - programming schedule

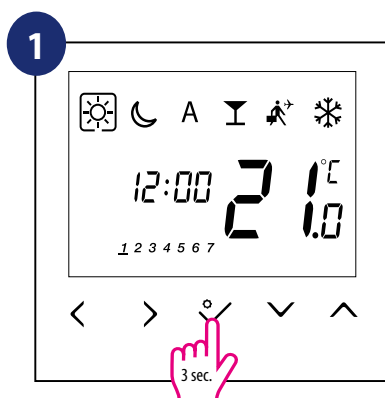
To program schedule, please follow steps below:



Hold  button for 3 seconds to enter the menu.

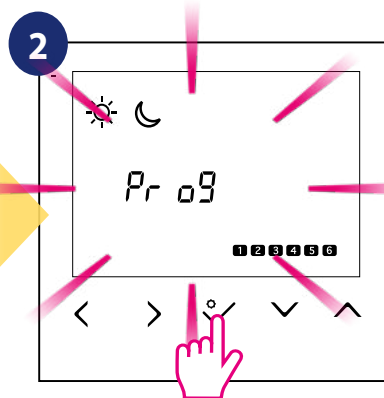

Enter into the schedule settings.

**3** There are 4 possible schedule variants. Use  and  buttons to select schedule variant and confirm by  button:

Separate schedule for **WORKING DAYS**.

Separate schedule for **WEEKENDS**.

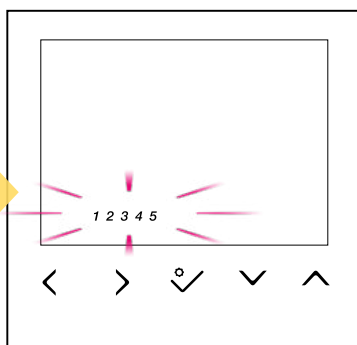

One schedule for **WHOLE WEEK**

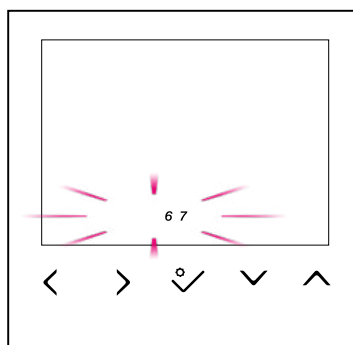

Seven separate schedules for **SINGLE DAYS**

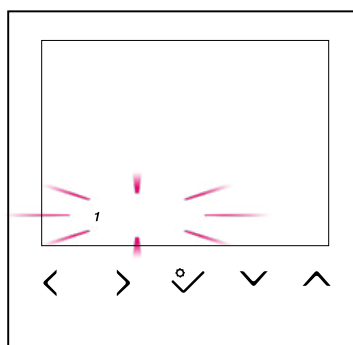
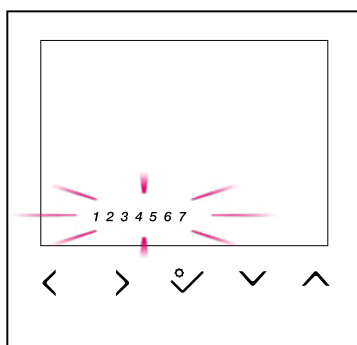

**Schedule programming example for the WORKING DAYS variant:**

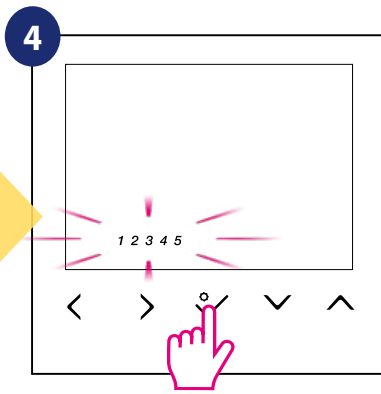

Select schedule variant by ✓ button.

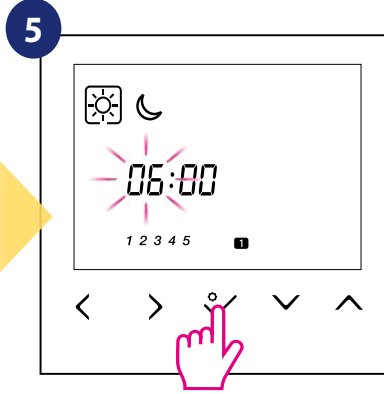

Use ▼ or ▲ buttons to set hour for the first program. Confirm by ✓ button.

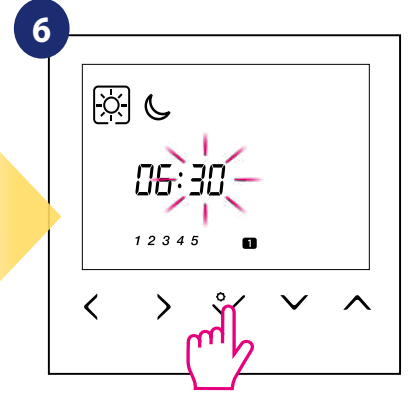

Use ▼ or ▲ buttons to set minutes for the first program. Confirm by ✓ button.

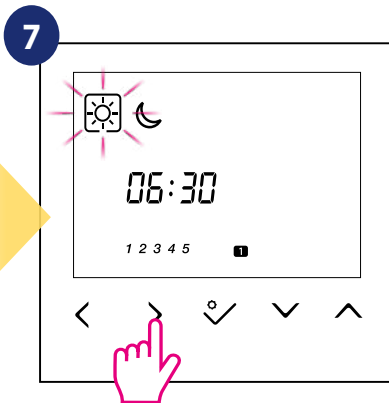

Use < and > buttons to choose comfort or economic setpoint temperature.

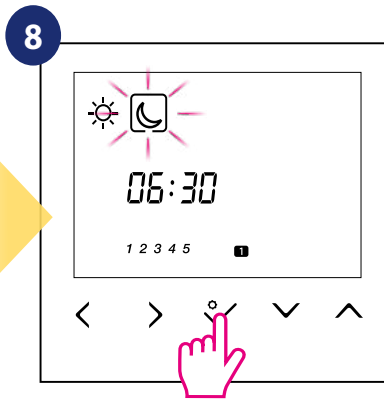

Confirm by ✓ button.

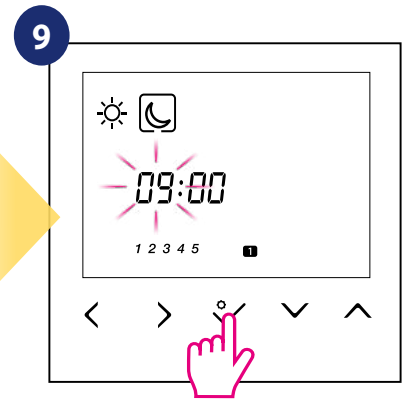

Schedule editing will jump to the next program's time setting. Set time for selected mode using ▼ or ▲ buttons again. Confirm by ✓ button.

**10** Repeat steps 5 and 9 for the next time periods in the schedule to set whole program for selected variant. No time --:-- on the display means given program is skipped. There are 6 programs/time periods in the schedule. Hold ✓ button for 3 seconds to save and exit schedule editing.

To run the schedule (activate thermostat's automatic mode), use < and > buttons to move the frame to the „A“ icon.

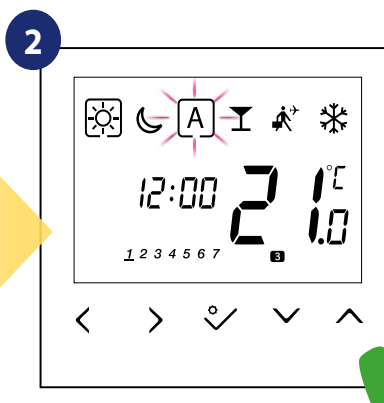
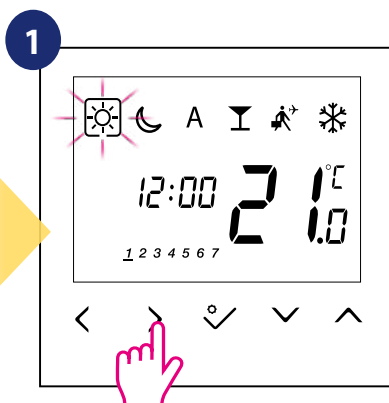

In addition to editing and creating your own schedule, there are also 5 default profiles for built-in schedules. You can select and customize any of the programs listed below. Default programs are selectable through Installer Parameters (parameter D17).

**Program Profile 1**

5 days (Monday to Friday)				2 days (Saturday to Sunday)			
Program	Program Time	Heat set point	Cool set point	Program	Program Time	Heat set point	Cool set point
1	6:00	☀	☀	1	7:00	☀	☀
2	9:00	☾	☾	2	23:00	☾	☾
3	16:00	☀	☀	3	--:--	--:--	--:--
4	23:00	☾	☾	4	--:--	--:--	--:--
5	--:--	--:--	--:--	5	--:--	--:--	--:--
6	--:--	--:--	--:--	6	--:--	--:--	--:--

**Program Profile 2**

5 days (Monday to Friday)				2 days (Saturday to Sunday)			
Program	Program Time	Heat set point	Cool set point	Program	Program Time	Heat set point	Cool set point
1	6:00	☀	☀	1	7:00	☀	☀
2	22:30	☾	☾	2	23:00	☾	☾
3	--:--	--:--	--:--	3	--:--	--:--	--:--
4	--:--	--:--	--:--	4	--:--	--:--	--:--
5	--:--	--:--	--:--	5	--:--	--:--	--:--
6	--:--	--:--	--:--	6	--:--	--:--	--:--

**Program Profile 3**

5 days (Monday to Friday)				2 days (Saturday to Sunday)			
Program	Program Time	Heat set point	Cool set point	Program	Program Time	Heat set point	Cool set point
1	5:00	☀	☀	1	7:30	☀	☀
2	8:00	☾	☾	2	22:30	☾	☾
3	14:00	☀	☀	3	--:--	--:--	--:--
4	22:00	☾	☾	4	--:--	--:--	--:--
5	--:--	--:--	--:--	5	--:--	--:--	--:--
6	--:--	--:--	--:--	6	--:--	--:--	--:--

**Program Profile 4**

5 days (Monday to Friday)				2 days (Saturday to Sunday)			
Program	Program Time	Heat set point	Cool set point	Program	Program Time	Heat set point	Cool set point
1	6:00	☀	☀	1	7:30	☀	☀
2	9:00	☾	☾	2	23:00	☾	☾
3	15:00	☀	☀	3	--:--	--:--	--:--
4	22:30	☾	☾	4	--:--	--:--	--:--
5	--:--	--:--	--:--	5	--:--	--:--	--:--
6	--:--	--:--	--:--	6	--:--	--:--	--:--

**Program Profile 5**

5 days (Monday to Friday)				2 days (Saturday to Sunday)			
Program	Program Time	Heat set point	Cool set point	Program	Program Time	Heat set point	Cool set point
1	6:00	☀	☀	1	7:30	☀	☀
2	10:00	☾	☾	2	23:30	☾	☾
3	16:00	☀	☀	3	--:--	--:--	--:--
4	23:00	☾	☾	4	--:--	--:--	--:--
5	--:--	--:--	--:--	5	--:--	--:--	--:--
6	--:--	--:--	--:--	6	--:--	--:--	--:--

## 5.2 Time/Date

To set time/date follow steps below:

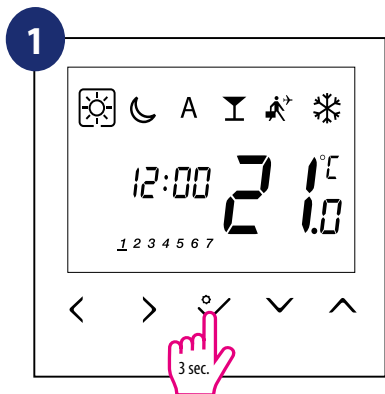

Hold button for 3 seconds to enter the menu.

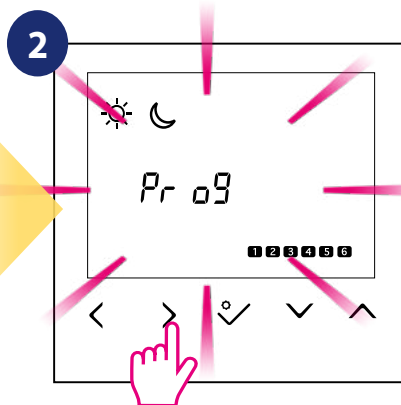

Go to the time and date settings using button.

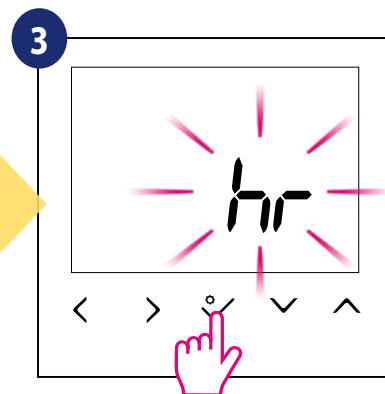

Choose time and date settings option by button.

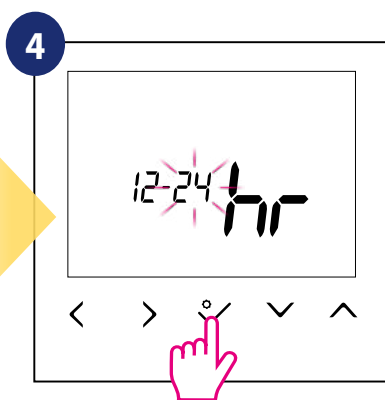

First, select time format (12/24h) using and buttons. Confirm by button.

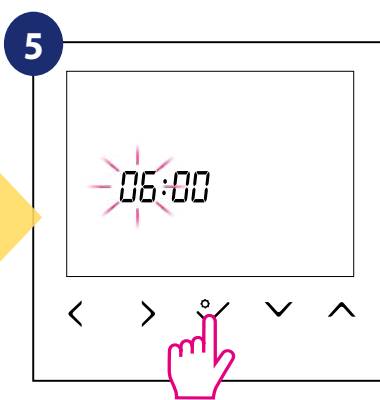

Set hour using and buttons. Confirm by button.

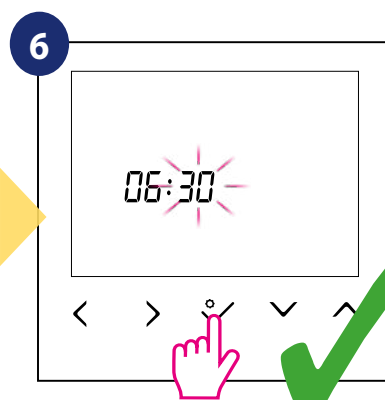

Set minutes using and buttons. Confirm by button.

### DATE settings will automatically appear after clock setup:

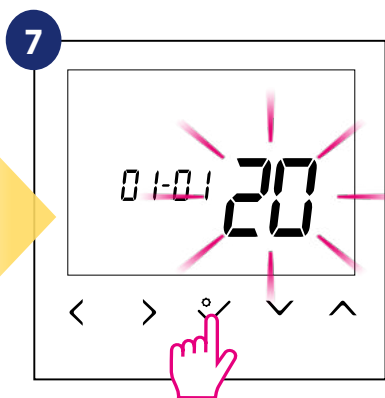

Set year using and buttons. Confirm by button.

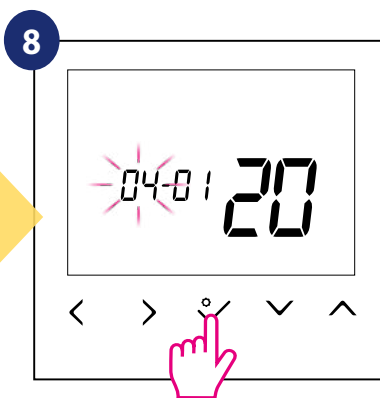

Set month using and buttons. Confirm by button.

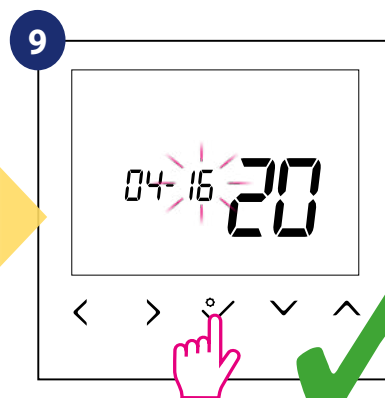

Set day using and buttons. Confirm by button.

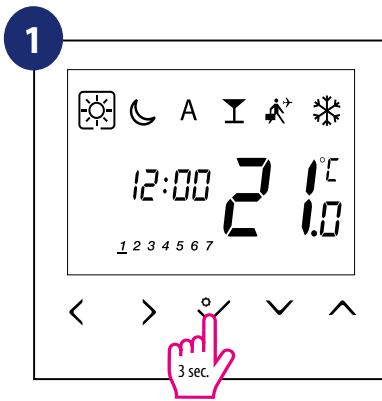

### 5.3 Thermostat calibration

Thermostat calibration is a function which allows user to recalibrate internal thermostat's temperature sensor by a given number of degrees (in the range from -3,0 °C to 3,0 °C in 0,5 °C steps). To calibrate thermostat's temperature sensor please follow steps below:

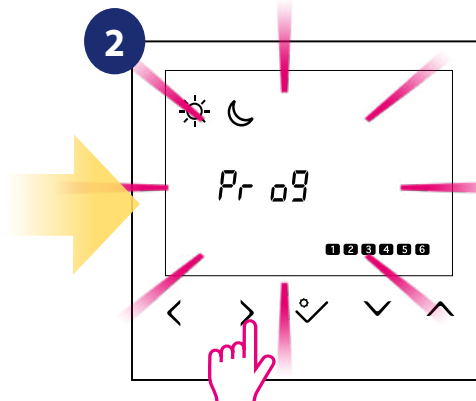

Hold  button for 3 seconds to enter the menu.



Go to the thermostat calibration settings using  and  buttons.

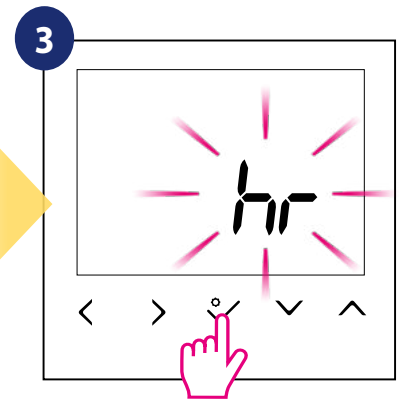

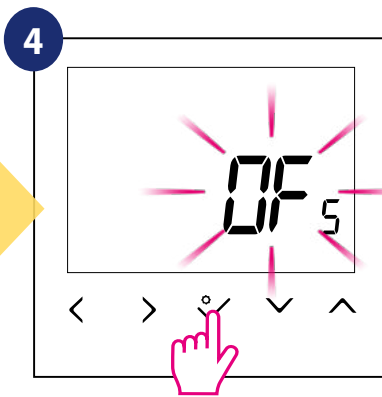

Move forward using  button.



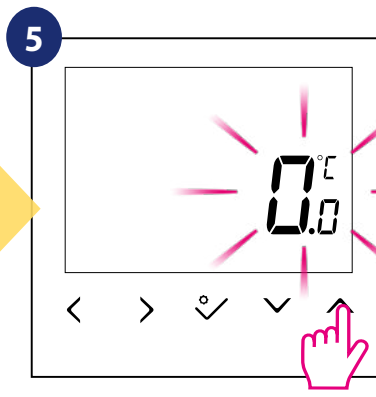

Confirm by  button.

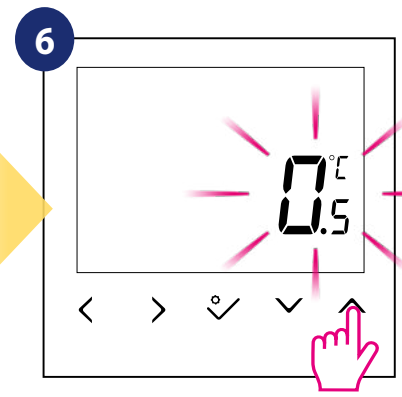

Set temperature calibration value using  and  buttons.



To increase/decrease value use  and  buttons.

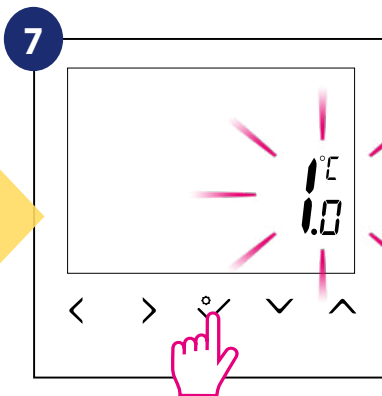

Confirm by  button.

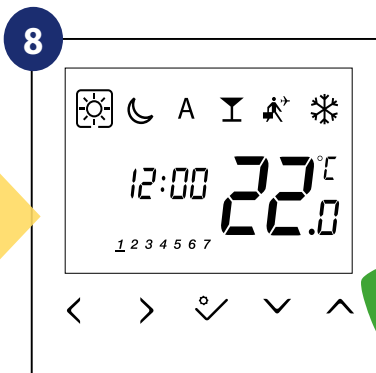

Thermostat will go back to the main screen after saving the settings.

## 5.4 Heat/cool mode change

The heating / cooling mode for the thermostat can be changed manually or automatically via „CO“ terminal. If 230V power is applied to the „CO“ terminal - then thermostat automatically switches to cooling mode. If you use this function in automatic mode, set the d18 parameter value to „1“.

MANUALLY:

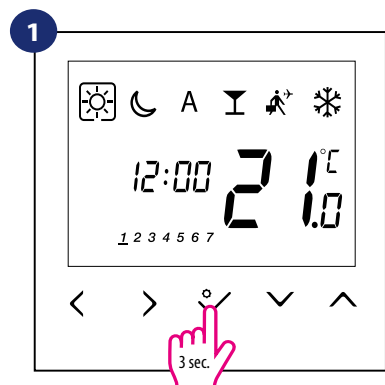

Hold button for 3 seconds to enter the menu.  
Then use button to choose heating/cooling settings.  
Confirm by button.

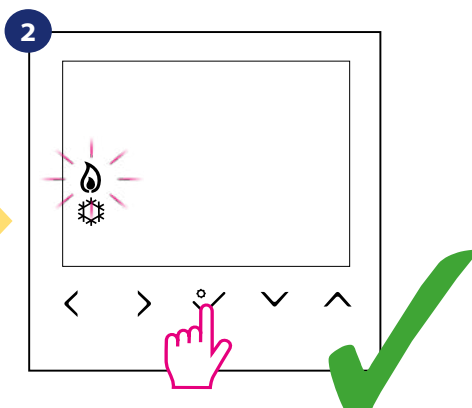

Set thermostat for heating using and buttons.  
Confirm by button.

AUTOMATICALLY:

By external ON/OFF switch:

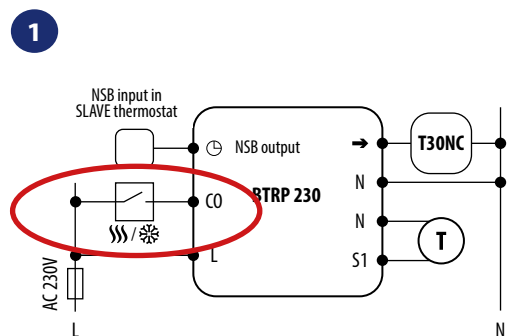

The heating / cooling mode for the thermostat can be changed manually or automatically via „CO“ terminal. If 230V power is applied to the „CO“ terminal - then thermostat automatically switches to cooling mode.

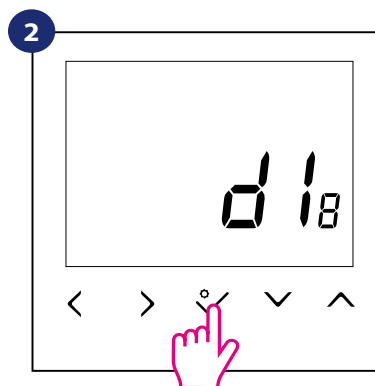

If we are using this option then d18 parameter should be set to „1“.  
Move in settings using and buttons. Confirm by button.



## 6. Installer parameters

To enter installer parameters please follow steps below. Please refer to parameters table description before any changes. Use  $\nabla$  or  $\blacktriangle$  buttons to move up or down between all parameters. Every change/selection confirm by  $\checkmark$  button:

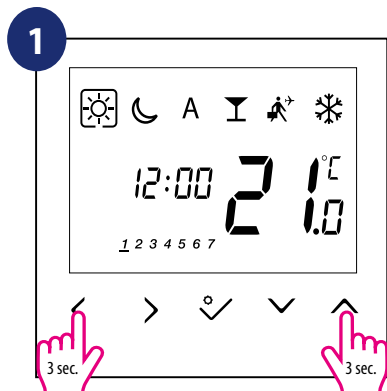

Hold  $\leftarrow + \blacktriangle$  buttons for 3 seconds to enter the installer mode.

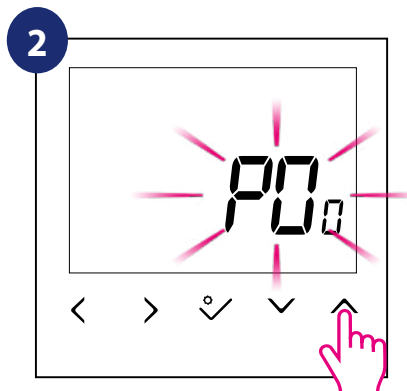

Use  $\nabla$  or  $\blacktriangle$  to choose code „49“.

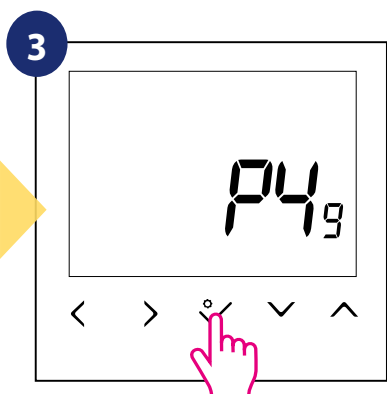

Press  $\checkmark$  button to confirm.

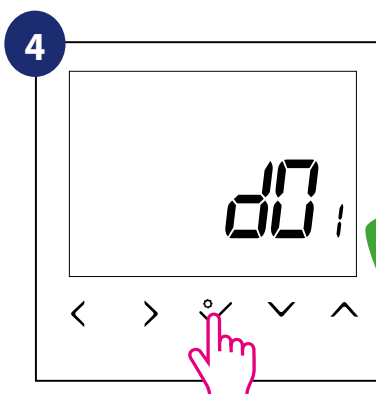

Select installer parameter by  $\leftarrow$  or  $\rightarrow$  buttons. Use  $\nabla$  or  $\blacktriangle$  buttons to change parameter value. Confirm choice by  $\checkmark$  button.

dXX	Function	Parameter Values	Description	Default Values
d01	Heating Control	This parameter defines the algorithm of the room temperature control.		0
		0	PWM (Pulse-width modulation) algorithm ensures reduction of overdrive states and economic operation of the system. It is an advanced algorithm designed to precisely maintain room temperature.	
		1	SPAN $\pm 0.25^{\circ}\text{C}$ ( $\pm 0.5^{\circ}\text{F}$ )	
		2	SPAN $\pm 0.5^{\circ}\text{C}$ ( $\pm 1.0^{\circ}\text{F}$ )	
d02	Room temp. offset	$-3.0^{\circ}\text{C}$ to $+3.0^{\circ}\text{C}$	Offset room temperature measuring is a function which allows user to recalibrate internal thermostat's temperature sensor by a given number of degrees (in the range from $-3,0^{\circ}\text{C}$ to $3,0^{\circ}\text{C}$ in $0,5^{\circ}\text{C}$ steps).	$0.0^{\circ}\text{C}$
d03	OUT sensor probe (S1/S2)	0	Out sensor probe not connected	0
		1	Out sensor probe connected	
d04	Air sensor or Floor sensor	0	Air sensor: If parameter d03 is inactive (d03 = 0) then internal sensor controls the temperature Air sensor: If parameter d03 is active (d03 = 1) then internal sensor is disabled and OUT sensor controls the temperature	0
		1	Floor sensor: If parameter d03 is inactive (d03 = 0) then internal sensor controls the temperature Floor sensor: If parameter d03 is active (d03 = 1) then internal sensor is disabled and OUT sensor controls the floor protection temperature	

dXX	Function	Parameter Values	Description	Default Values
d05	Cooling Control	1	SPAN $\pm 0.25^{\circ}\text{C}$ ( $\pm 0.5^{\circ}\text{F}$ )	2
		2	SPAN $\pm 0.5^{\circ}\text{C}$ ( $\pm 1.0^{\circ}\text{F}$ )	
d07	Valve Protection	1	Enable. Valve protection function is intended to protect thermostatic valves against getting stuck or jamming (e.g. in summer time when heating system is disabled). If thermostat doesn't send a signal for heating for a period of 7 days, then heating is turned on for a very short period of time just to move the actuators.	1
d08	Frost Setpoint	5°C - 17°C	In Frost protection mode the thermostat is displaying actual room temperature and maintain „frost protection“ setpoint temperature specified in thermostat settings. When thermostat works in Frost protection mode then you have no possibilities to change temperature setpoint.	5.0°C
d09	12/24 Hour Format	0	12hours	1
		1	24hours	
d11	Daylight Saving Time (DST)	0	Off	1
		1	On	
d12	Maximum limitation of heating setpoint	5°C - 35°C	This parameter allows to limit temperature setpoint range by setting maximum setpoint for heating and cooling modes. Default temperature setting range: 5°C - 35°C	35°C
d13	Minimum limitation of cooling setpoint	5°C - 40°C	This parameter allows to limit temperature setpoint range by setting minimum setpoint for heating and cooling modes. Default temperature setting range: 5°C - 40°C	5°C
d14*	Floor sensor protection limit (heating high limit-HL)	11°C - 45°C	Turn off relay output when floor sensing temp > protecting limit, step is 0.5°C	27°C
d15*	Floor sensor protection limit (heating low limit-LL)	6°C - 40°C	Turn on relay output when floor sensing temp < protecting limit, step is 0.5°C	10°C
d16*	Floor sensor protection limit (cooling)	6°C - 45°C	Turn off relay output when floor sensing temp < protecting limit, step is 0.5°C	6°C
d17	Preset program selection	1-5	Select one of these 5 default programs. Once selected, default program will overwrite present program. Selected default program can be edited by the user in the User Setting Mode.	1
d18	Heat/Cool Mode Selection	0	No connection	0
		1	Connection	
d19**	Cooling Blocked	0	Cooling disabled	0
		1	Cooling allowed	
d20	Actuators loading selection for different temperature compensation.	1	x1 actuator loading	1
		2	x2 actuators loading	
		3	x3 actuators loading	
		4	x4 actuators loading	
		5	x5 actuators loading	

\*Parameters d14, d15, d16 will be available only if parameter d04 is active (d04=1).

\*\*Cooling Blocked - at „1“ we block cooling for a single room until the device receives a heating command. During the blocking of the cooling function no message is displayed.



**\*\*Please note!**

d19 parameter will be available only if d18 is set on 1.

## 7. Factory Reset

To **RESET** BTRP230V(50) thermostat to it's factory default settings please follow steps below:

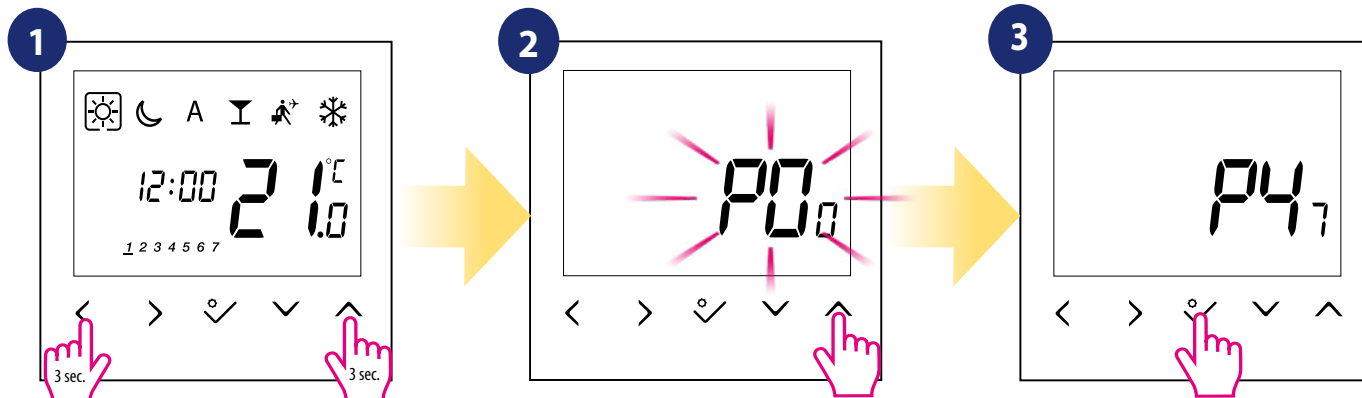

Hold <+^ buttons for 3 seconds to enter the installer mode.

Use v or ^ buttons to choose code „47”.

Press ✓ button to confirm.

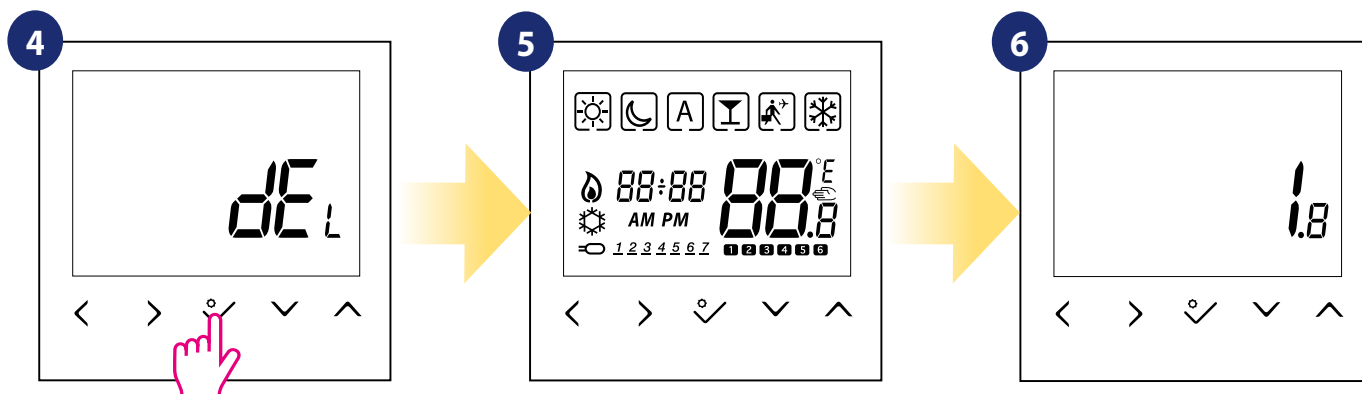

Select „del” and confirm choice by pressing ✓ button.

Wait few moments to finish factory reset procedure...

...thermostat will display the software version...

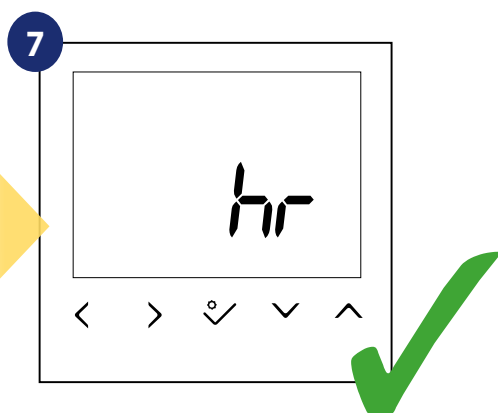

...after all - screen with time and date selection will appear.

## 8. Error codes

Thermostat constantly monitors the operation of connected sensors. If it detects any failure then following error codes can be displayed.

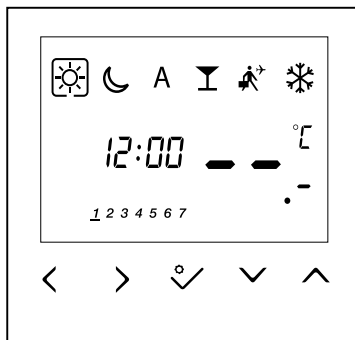

View of the display when the external sensor has been selected as air temperature measurement (installer parameters D03 = 1 and D04 = 0), but it is broken or not connected.

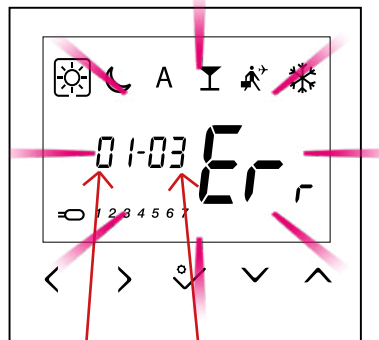

Number of errors      Error code

Display view when an external sensor has been selected as a floor sensor (installer parameters D03 = 1 and D04 = 0). Applies to error codes - Err02, Err03 and Err04. Check the table below for a solution.

Error code	ERROR DESCRIPTION	TROUBLESHOOTING
<b>Err02</b>	The maximum / minimum floor temperature has been exceeded	<ul style="list-style-type: none"> <li>• Set the heating / cooling medium temperature or change D14 / D15 parameter.</li> </ul>
<b>Err03</b>	Floor sensor is faulty	<ul style="list-style-type: none"> <li>• If floor sensor is connected to S1/S2 input, check the wiring.</li> <li>• If floor sensor is not connected, check the D03/D04 parameters settings.</li> </ul>
<b>Err04</b>	Floor sensor is shorted	<ul style="list-style-type: none"> <li>• Check floor sensor wire insulation for any damages. Sensor resistance for 25°C=10kΩ.</li> </ul>

## 9. Cleaning and Maintenance

The **BTRP230V(50) thermostat** requires no special maintenance. Periodically, the outer casing can be wiped clean using a dry cloth (please DO NOT use solvents, polishes, detergents or abrasive cleaners, as these can damage the thermostat). There are no user serviceable parts within the unit; any servicing or repairs could only be carried out by **Salus Controls** or their appointed agents.

## 10. Technical Informations

Power supply	230 V AC 50 Hz
Rating max	0,5 A
Temperature setback	Adjustable
Temperature range	5°C – 35°C
Span	+/- 0,5°C
Storage temperature	-20°C to +60°C
Ambient temperature	0 °C up to 45 °C
Degree of protection	IP 30
CE conformity according to	Class II ( EN60730 )
Housing material	PC, V2
Color	RAL 9010 pure white
Control method	PWM algorithm Hysteresis +/-0,5°C or +/-0,25°C
Connection	Screw terminal
Puls-wide-modulation (PWM)	Yes
Clock, Timer	Yes, programmable
Heating and Cooling	Yes, automatic modes changeover through CO terminal
Parameter adjustment	Yes, in Installer Mode
Dimensions	71mm x 71mm x 46mm

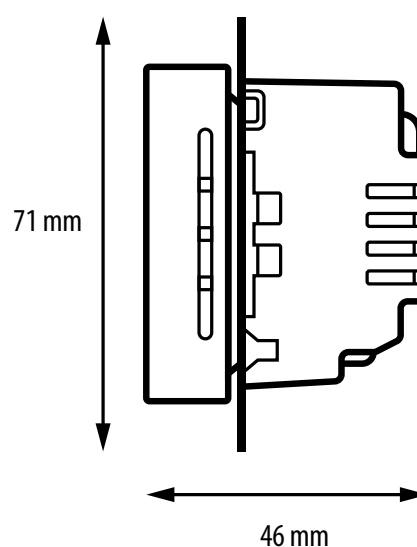
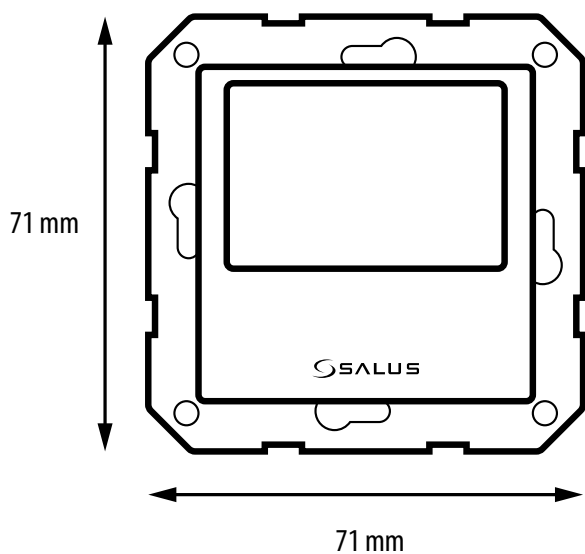

**11. Warranty**

SALUS Controls warrants that this product will be free from any defect in materials or workmanship, and shall perform in accordance with its specification, for a period of five years from the date of installation. SALUS Controls sole liability for breach of this warranty will be (at its option) to repair or replace the defective product.

Customer Name: .....
Customer Address: .....
..... Post Code: .....
Tel No: ..... Email: .....
Company Name: .....
Tel No: ..... Email: .....
Installation Date: .....
Installer Name: .....
Installer Signature: .....



**DISTRIBUTOR OF SALUS CONTROLS:**

QL CONTROLS Sp. z o.o., Sp. k.

Rolna 4,

43-262 Kobielice,

Poland

**IMPORTER:**

SALUS Controls Plc

Units 8-10 Northfield Business Park

Forge Way, Parkgate

Rotherham

S60 1SD

United Kingdom



[www.salus-controls.com](http://www.salus-controls.com)

SALUS Controls is a member of the Computime Group.

Maintaining a policy of continuous product development SALUS Controls plc reserve the right to change specification, design and materials of products listed in this brochure without prior notice.

Ver. 4

Issued: 14 IX 2020

Soft version: 1.8

